

# Plastic Medium Power Silicon NPN Transistor

... designed for use in 5.0 to 10 Watt audio amplifiers and drivers utilizing complementary or quasi complementary circuits.

- DC Current Gain —  $h_{FE} = 40$  (Min) @  $I_C = 0.15$  Adc

## MAXIMUM RATINGS

Rating	Symbol	Value	Unit
Collector–Emitter Voltage	$V_{CEO}$	80	Vdc
Collector–Base Voltage	$V_{CBO}$	100	Vdc
Emitter–Base Voltage	$V_{EBO}$	5.0	Vdc
Collector Current	$I_C$	2.0	Adc
Base Current	$I_B$	1.0	Adc
Total Device Dissipation @ $T_C = 25^\circ\text{C}$	$P_D$	25	Watts
Operating and Storage Junction Temperature Range	$T_J, T_{stg}$	-55 to +150	$^\circ\text{C}$

## THERMAL CHARACTERISTICS

Characteristic	Symbol	Max	Unit
Thermal Resistance, Junction to Case	$\theta_{JC}$	5.0	$^\circ\text{C/W}$

## ELECTRICAL CHARACTERISTICS ( $T_C = 25^\circ\text{C}$ unless otherwise noted)

Characteristic	Symbol	Min	Max	Unit
Collector–Emitter Sustaining Voltage* ( $I_C = 0.1$ Adc, $I_B = 0$ )	$V_{(BR)CEO}$	80	—	Vdc
Collector Cutoff Current ( $V_{CB} = 100$ Vdc, $I_E = 0$ )	$I_{CBO}$	—	0.1	mAdc
Emitter Cutoff Current ( $V_{BE} = 5.0$ Vdc, $I_C = 0$ )	$I_{EBO}$	—	1.0	mAdc
DC Current Gain ( $I_C = 0.15$ A, $V_{CE} = 2.0$ V) ( $I_C = 1.0$ A, $V_{CE} = 2.0$ V)	$h_{FE1}$ $h_{FE2}$	40 25	— —	
Collector–Emitter Saturation Voltage* ( $I_C = 1.0$ Adc, $I_B = 0.1$ Adc)	$V_{CE(sat)}$	—	0.6	Vdc
Base–Emitter On Voltage* ( $I_C = 1.0$ Adc, $V_{CE} = 2.0$ Vdc)	$V_{BE(on)}$	—	1.3	Vdc
Current–Gain — Bandwidth Product ( $I_C = 250$ mAdc, $V_{CE} = 10$ Vdc, $f = 1.0$ MHz)	$f_T$	3.0	—	MHz

\* Pulse Test: Pulse Width  $\leq 300$   $\mu\text{s}$ , Duty Cycle  $\leq 2.0\%$ .

**BD237**

**2.0 AMPERES  
POWER TRANSISTORS  
NPN SILICON  
80 VOLTS  
25 WATTS**

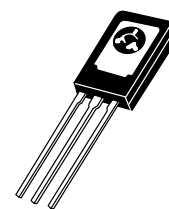

**CASE 77-08  
TO-225AA TYPE**

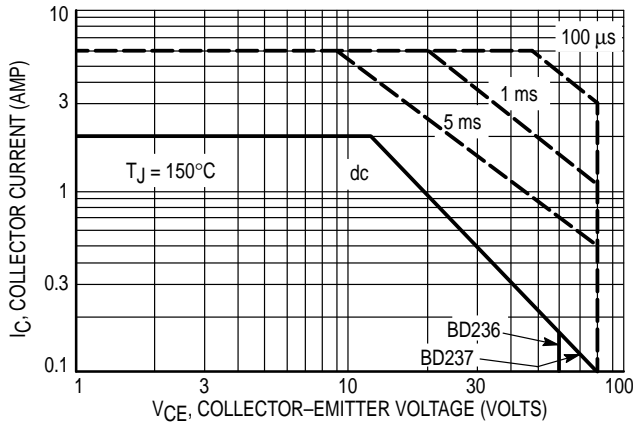

Figure 1. Active Region Safe Operating Area

The Safe Operating Area Curves indicate  $I_C - V_{CE}$  limits below which the device will not enter secondary breakdown. Collector load lines for specific circuits must fall within the applicable Safe Area to avoid causing a catastrophic failure. To insure operation below the maximum  $T_J$ , power-temperature derating must be observed for both steady state and pulse power conditions.

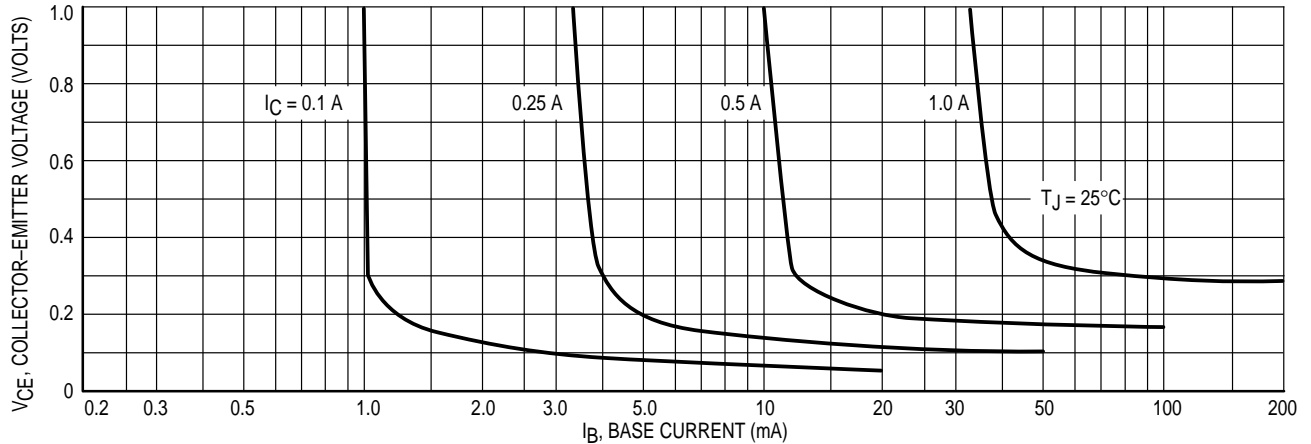

Figure 2. Collector Saturation Region

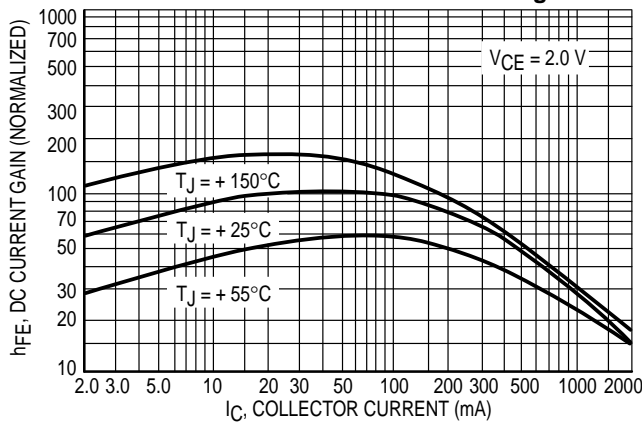

Figure 3. Current Gain

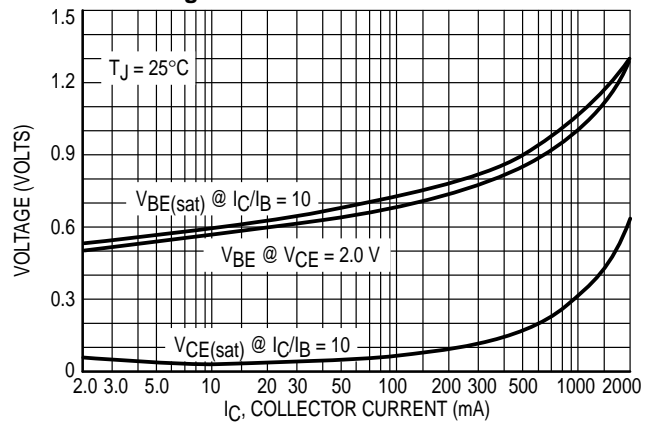

Figure 4. "On" Voltages

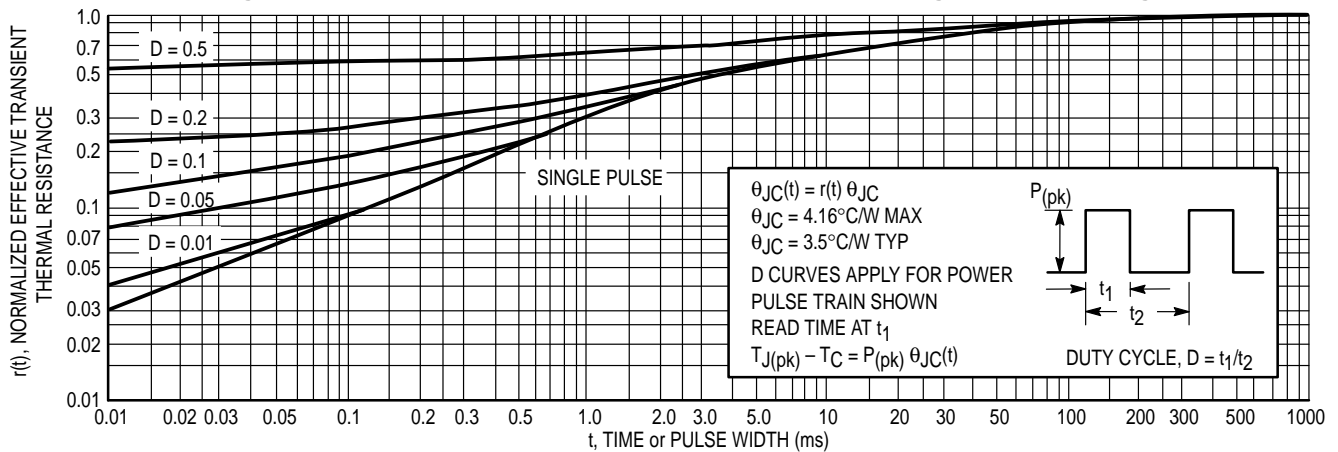
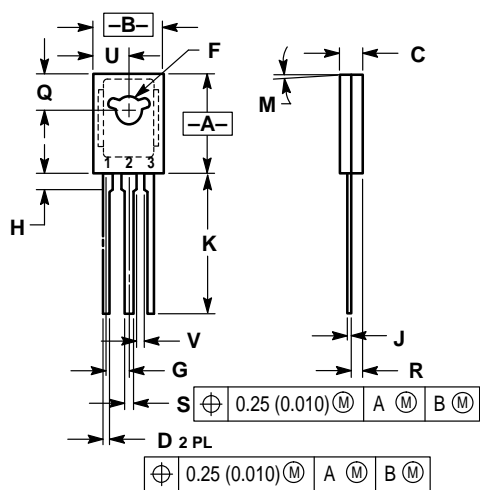

Figure 5. Thermal Response

PACKAGE DIMENSIONS



- NOTES:  
 1. DIMENSIONING AND TOLERANCING PER ANSI Y14.5M, 1982.  
 2. CONTROLLING DIMENSION: INCH.

DIM	INCHES		MILLIMETERS	
	MIN	MAX	MIN	MAX
A	0.425	0.435	10.80	11.04
B	0.295	0.305	7.50	7.74
C	0.095	0.105	2.42	2.66
D	0.020	0.026	0.51	0.66
F	0.115	0.130	2.93	3.30
G	0.094 BSC		2.39 BSC	
H	0.050	0.095	1.27	2.41
J	0.015	0.025	0.39	0.63
K	0.575	0.655	14.61	16.63
M	5° TYP		5° TYP	
Q	0.148	0.158	3.76	4.01
R	0.045	0.055	1.15	1.39
S	0.025	0.035	0.64	0.88
U	0.145	0.155	3.69	3.93
V	0.040	—	1.02	—

STYLE 1:  
 PIN 1. EMITTER  
 2. COLLECTOR  
 3. BASE

CASE 77-08  
 TO-225AA TYPE  
 ISSUE V

Motorola reserves the right to make changes without further notice to any products herein. Motorola makes no warranty, representation or guarantee regarding the suitability of its products for any particular purpose, nor does Motorola assume any liability arising out of the application or use of any product or circuit, and specifically disclaims any and all liability, including without limitation consequential or incidental damages. "Typical" parameters can and do vary in different applications. All operating parameters, including "Typicals" must be validated for each customer application by customer's technical experts. Motorola does not convey any license under its patent rights nor the rights of others. Motorola products are not designed, intended, or authorized for use as components in systems intended for surgical implant into the body, or other applications intended to support or sustain life, or for any other application in which the failure of the Motorola product could create a situation where personal injury or death may occur. Should Buyer purchase or use Motorola products for any such unintended or unauthorized application, Buyer shall indemnify and hold Motorola and its officers, employees, subsidiaries, affiliates, and distributors harmless against all claims, costs, damages, and expenses, and reasonable attorney fees arising out of, directly or indirectly, any claim of personal injury or death associated with such unintended or unauthorized use, even if such claim alleges that Motorola was negligent regarding the design or manufacture of the part. Motorola and  are registered trademarks of Motorola, Inc. Motorola, Inc. is an Equal Opportunity/Affirmative Action Employer.

**How to reach us:**

**USA / EUROPE:** Motorola Literature Distribution;  
P.O. Box 20912; Phoenix, Arizona 85036. 1-800-441-2447

**JAPAN:** Nippon Motorola Ltd.; Tatsumi-SPD-JLDC, Toshikatsu Otsuki,  
6F Seibu-Butsuryu-Center, 3-14-2 Tatsumi Koto-Ku, Tokyo 135, Japan. 03-3521-8315

**MFAX:** RMFAX0@email.sps.mot.com - TOUCHTONE (602) 244-6609  
**INTERNET:** <http://Design-NET.com>

**HONG KONG:** Motorola Semiconductors H.K. Ltd.; 8B Tai Ping Industrial Park,  
51 Ting Kok Road, Tai Po, N.T., Hong Kong. 852-26629298



This datasheet has been download from:

[www.datasheetcatalog.com](http://www.datasheetcatalog.com)

Datasheets for electronics components.