

International  
**IYR** Rectifier

## 85HF(R) SERIES

STANDARD RECOVERY DIODES

Stud Version

### Features

- High surge current capability
- Stud cathode and stud anode version
- Leaded version available
- Types up to 1600V  $V_{RRM}$

85 A

### Typical Applications

- Battery charges
- Converters
- Power supplies
- Machine tool controls
- Welding

### Major Ratings and Characteristics

Parameters	85HF(R)		Units
	10 to 120	140 , 160	
$I_{F(AV)}$	85	85	A
@ $T_C$	140	110	°C
$I_{F(RMS)}$	133		A
$I_{FSM}$	@ 50Hz	1700	A
	@ 60Hz	1800	A
$I^2t$	@ 50Hz	14500	A <sup>2</sup> s
	@ 60Hz	13500	A <sup>2</sup> s
$V_{RRM}$ range	100 to 1200	1400 , 1600	V
$T_J$ range	- 65 to 180	- 65 to 150	°C

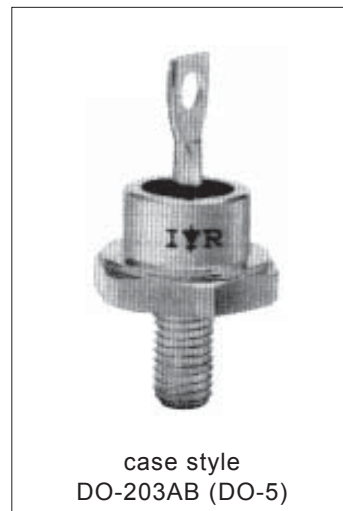

## 85HF(R) Series

Bulletin I20203 rev. C 03/04

International  
IRF Rectifier

### ELECTRICAL SPECIFICATIONS

#### Voltage Ratings

Type number	Voltage Code	$V_{RRM}$ , maximum repetitive peak reverse voltage V	$V_{RSM}$ , maximum non-repetitive peak reverse voltage V	$I_{RRM}$ max. @ $T_J = T_J$ max. mA
85HF(R)	10	100	200	9
	20	200	300	
	40	400	500	
	60	600	700	
	80	800	900	
	100	1000	1100	
	120	1200	1300	
	140	1400	1500	4.5
160	1600	1700		

#### Forward Conduction

Parameter	85HF(R)		Units	Conditions		
	10 to 120	140, 160				
$I_{F(AV)}$ Max. average forward current @ Case temperature	85	85	A	180° conduction, half sine wave		
	140	110	°C			
$I_{F(RMS)}$ Max. RMS forward current	133		A			
$I_{FSM}$ Max. peak, one-cycle forward, non-repetitive surge current	1700		A	t = 10ms	No voltage reappplied	Sinusoidal half wave, Initial $T_J = T_J$ max.
	1800			t = 8.3ms	reappplied	
	1450			t = 10ms	100% $V_{RRM}$	
	1500			t = 8.3ms	reappplied	
$I^2t$ Maximum $I^2t$ for fusing	14500		A <sup>2</sup> s	t = 10ms	No voltage reappplied	
	13500			t = 8.3ms	reappplied	
	10500			t = 10ms	100% $V_{RRM}$	
	9400			t = 8.3ms	reappplied	
$I^2\sqrt{t}$ Maximum $I^2\sqrt{t}$ for fusing	16000		A <sup>2</sup> √s	t = 0.1 to 10ms, no voltage reappplied		
$V_{F(TO)}$ Value of threshold voltage (up to 1200V)	0.68		V	$T_J = T_J$ max.		
$V_{F(TO)}$ Value of threshold voltage (for 1400V, 1600V)	0.69			$T_J = T_J$ max.		
$r_f$ Value of forward slope resistance (up to 1200V)	1.62		mΩ	$T_J = T_J$ max.		
$r_f$ Value of forward slope resistance (up to 1200V)	1.75			$T_J = T_J$ max.		
$V_{FM}$ Max. forward voltage drop	1.2	1.4	V	$I_{pk} = 267A$ , $T_J = 25^\circ C$ , $t_p = 400\mu s$ rectangular wave		

Thermal and Mechanical Specifications

Parameter	85HF(R)		Units	Conditions
	10 to 120	140 to 160		
T <sub>J</sub> Max. junction operating temperature range	-65 to 180	-65 to 150	°C	
T <sub>stg</sub> Max. storage temperature range	-65 to 180	-65 to 150		
R <sub>thJC</sub> Max. thermal resistance, junction to case	0.35		K/W	DC operation
R <sub>thCS</sub> Max. thermal resistance, case to heatsink	0.25			Mounting surface, smooth, flat and greased
Maximum shock	1500g			<b>see note (1)</b>
Maximum constant vibration	20g			50Hz <b>see note (1)</b>
Maximum constant acceleration	5000g			Stud outwards <b>see note (1)</b>
T Max. allowed mounting torque ±10%	2.3 - 3.4		Nm	Not lubricated threads
	20 - 30		lbf·in	
wt Approximate weight	17 (0.6)		g (oz)	unleaded device
Case style	DO-203AB (DO5)			See Outline Table

(1) Available only for 88HF

$\Delta R_{thJC}$  Conduction

(The following table shows the increment of thermal resistance R<sub>thJC</sub> when devices operate at different conduction angles than DC)

Conduction angle	Sinusoidal conduction	Rectangular conduction	Units	Conditions
180°	0.10	0.08	K/W	T <sub>J</sub> = T <sub>J</sub> max.
120°	0.11	0.11		
90°	0.13	0.13		
60°	0.17	0.17		
30°	0.26	0.26		

Ordering Information Table

Device Code	
	<div style="display: flex; justify-content: space-around; align-items: center;"> <div style="border: 1px solid black; padding: 2px 5px; margin: 2px;">85</div> <div style="border: 1px solid black; padding: 2px 5px; margin: 2px;">HF</div> <div style="border: 1px solid black; padding: 2px 5px; margin: 2px;">R</div> <div style="border: 1px solid black; padding: 2px 5px; margin: 2px;">160</div> <div style="border: 1px solid black; padding: 2px 5px; margin: 2px;">M</div> </div> <div style="display: flex; justify-content: space-around; margin-top: 5px;"> <span>①</span> <span>②</span> <span>③</span> <span>④</span> <span>⑤</span> </div>
<b>1</b>	- 85 = Standard device 86 = Not isolated lead 87 = Isolated lead with silicone sleeve (Red = Reverse polarity) (Blue = Normal polarity) 88 = Type for rotating application
<b>2</b>	- Standard diode
<b>3</b>	- None = Stud Normal Polarity (Cathode to Stud) R = Stud Reverse Polarity (Anode to Stud)
<b>4</b>	- Voltage code: Code x 10 = V <sub>RRM</sub> (See Voltage Ratings table)
<b>5</b>	- None = Stud base DO-203AB (DO-5) 1/4" 28UNF-2A M = Stud base DO-203AB (DO-5) M6 X 1 - (Not available for 88HF)

**85HF(R) Series**

Bulletin I20203 rev. C 03/04

Outlines Table

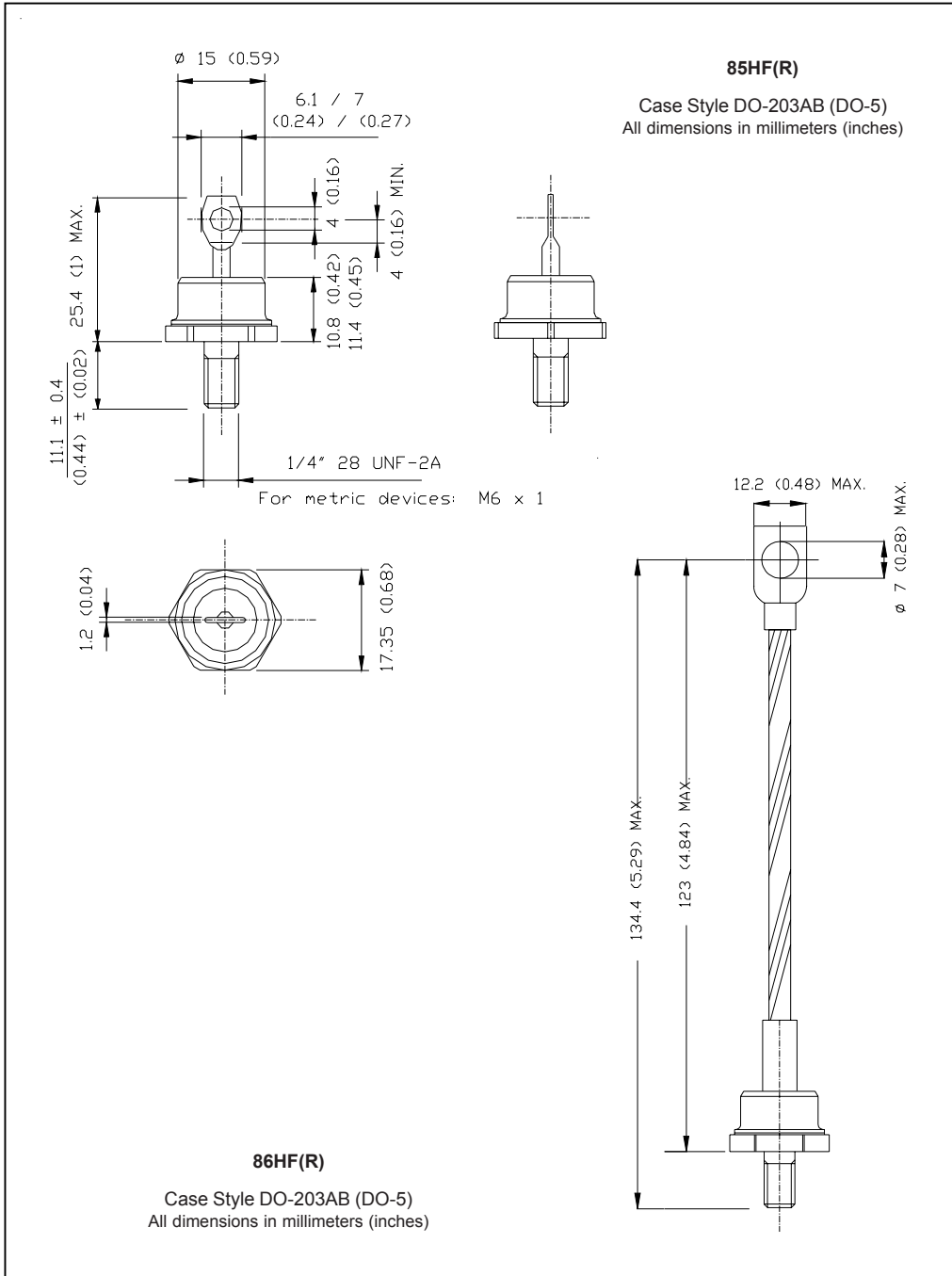

Outlines Table

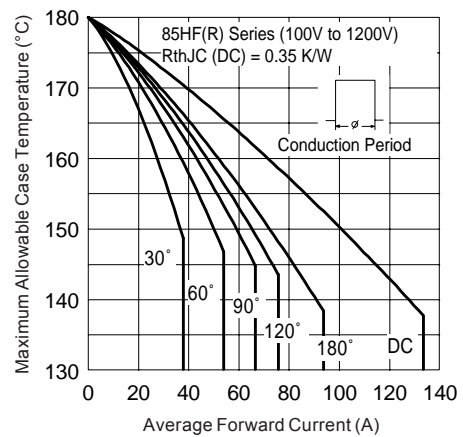
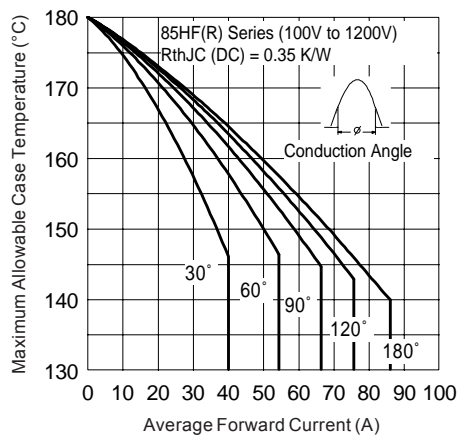
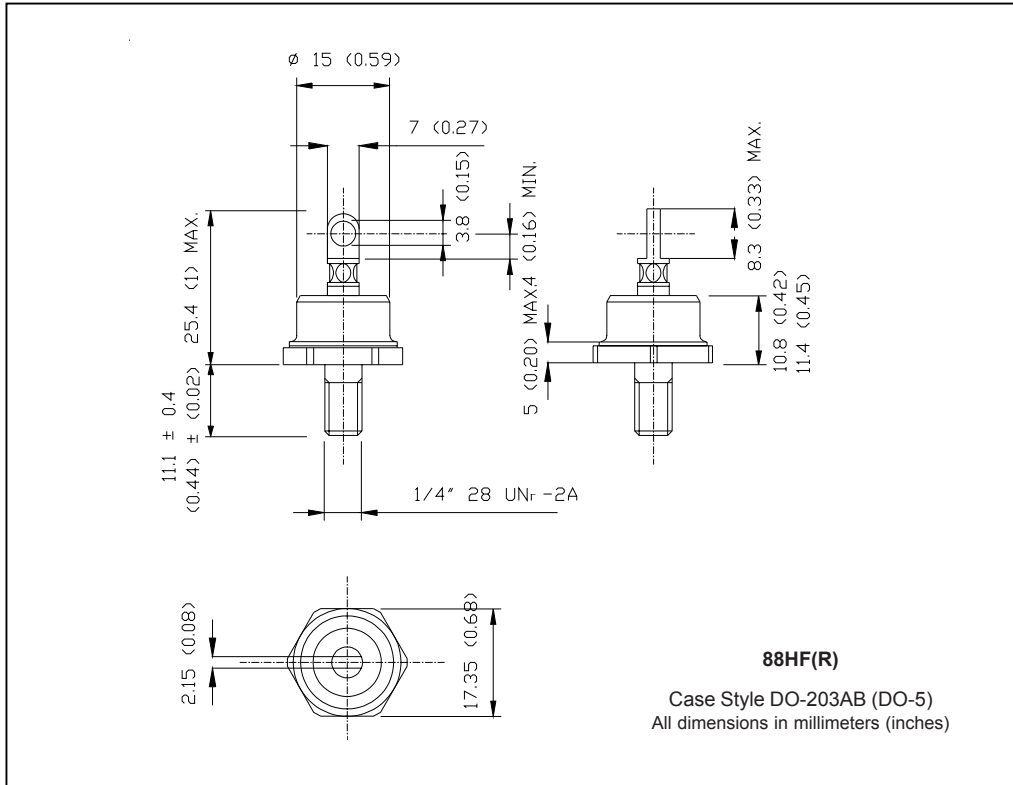

# 85HF(R) Series

Bulletin I20203 rev. C 03/04

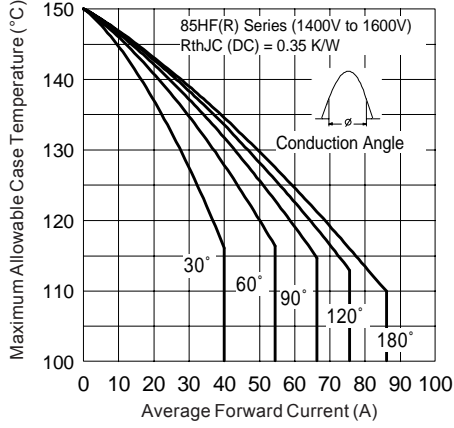

Fig. 3 - Current Ratings Characteristics

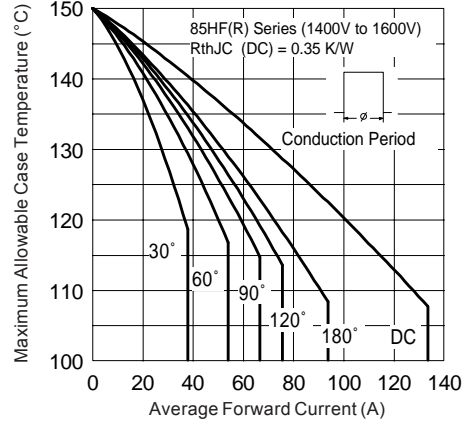

Fig. 4 - Current Ratings Characteristics

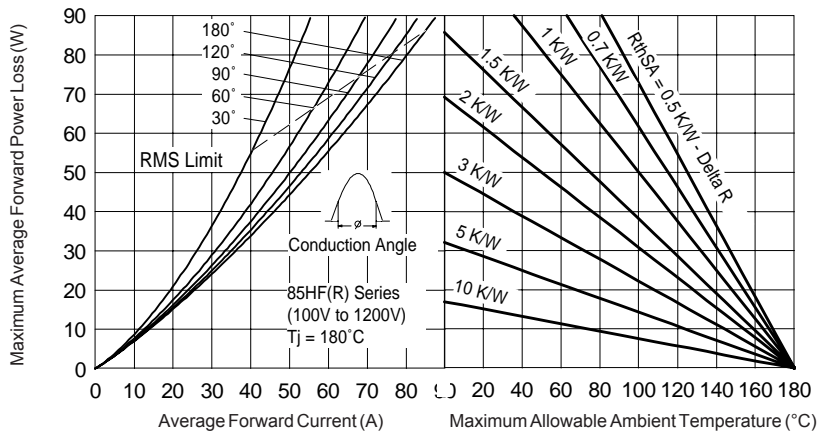

Fig. 5 - Forward Power Loss Characteristics

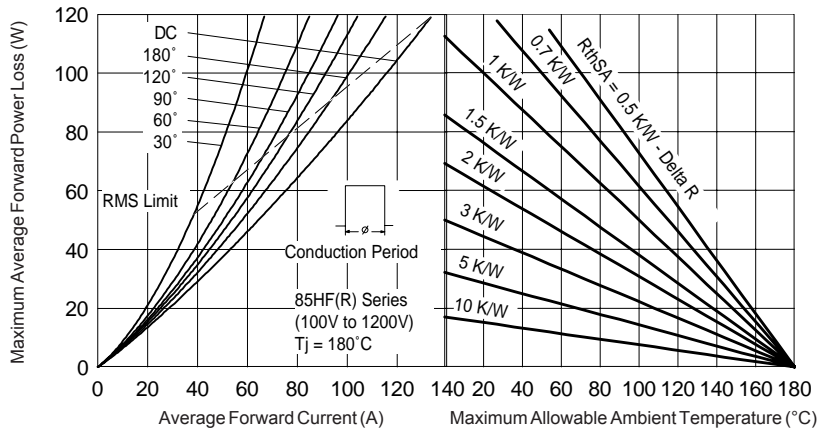

Fig. 6 - Forward Power Loss Characteristics

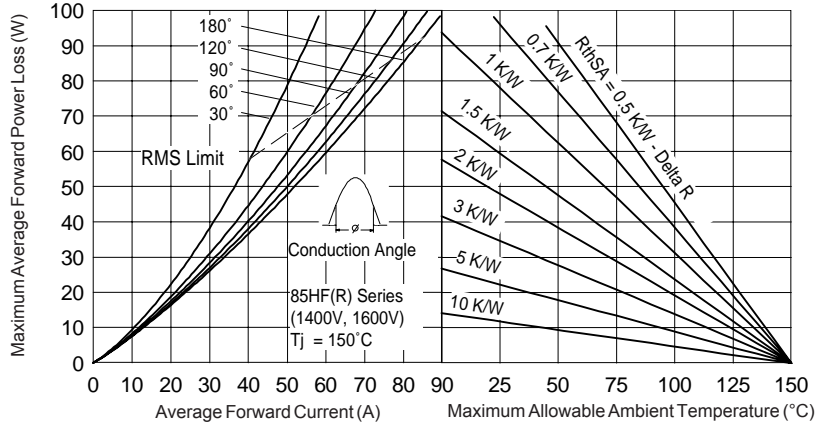

Fig. 7 - Forward Power Loss Characteristics

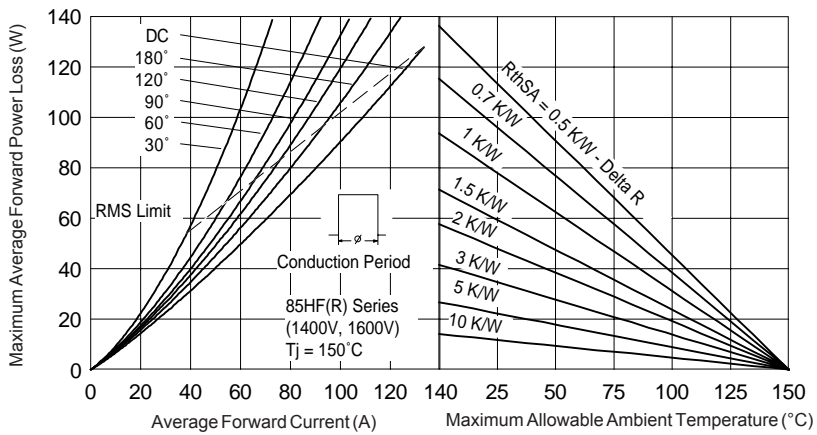

Fig. 8 - Forward Power Loss Characteristics

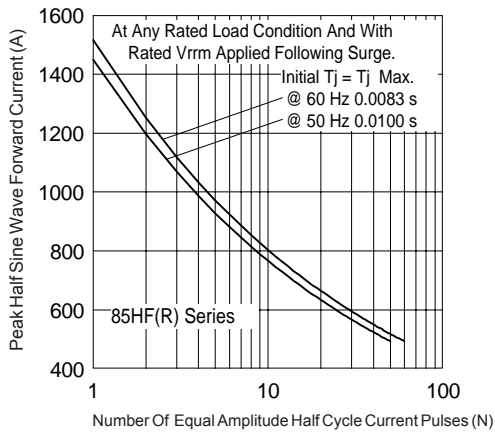

Fig. 9 - Maximum Non-Repetitive Surge Current

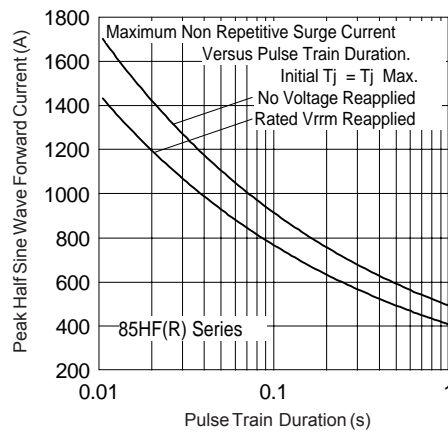

Fig. 10 - Maximum Non-Repetitive Surge Current

## 85HF(R) Series

Bulletin I20203 rev. C 03/04

International  
**IR** Rectifier

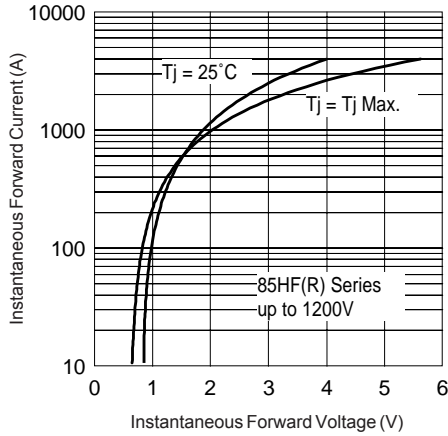

Fig. 11 - Forward Voltage Drop Characteristics (up to 1200V)

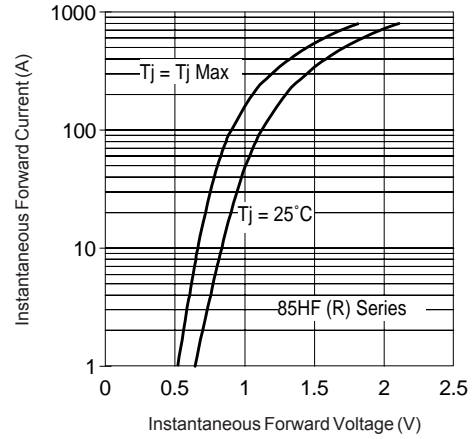

Fig. 12 - Forward Voltage Drop Characteristics (for 1400V, 1600V)

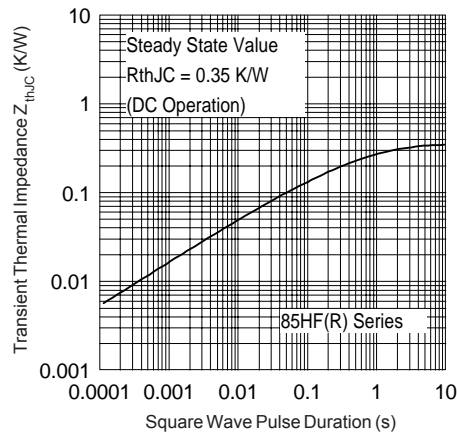

Fig. 13 - Thermal Impedance  $Z_{thJC}$  Characteristics

Data and specifications subject to change without notice.  
This product has been designed and qualified for Industrial Level.  
Qualification Standards can be found on IR's Web site.

International  
**IR** Rectifier

**IR WORLD HEADQUARTERS:** 233 Kansas St., El Segundo, California 90245, USA Tel: (310) 252-7105  
TAC Fax: (310) 252-7309  
Visit us at [www.irf.com](http://www.irf.com) for sales contact information. 03/04

This datasheet has been download from:

[www.datasheetcatalog.com](http://www.datasheetcatalog.com)

Datasheets for electronics components.